

Sink Quadra EVO

Kitchen Sinks

Code: 1255 050



DETAILS

Edge/Installation Type Flush-mount | Top-mount

Finish Foster brushed

Material AISI 304 stainless steel

Texture Brushed in line

Base 60 cm

Dimensions 570 x 470 mm

Standard fittings Fixing hooks, gasket, drain, overflow and siphon, boxed packing

Mixer holes No standard holes

Built-in hole View technical data sheet

Drainer No

Width 57 cm

Bowl dimension 530 x 430 mm

Number of bowls 1 bowl

Waste fitting 3,5" drain

EQUIPMENT

1 x Black Grid 8100 615

FEATURES

Basket 3,5" waste fitting The drain is equipped with a large 3.5" drain, with the practical basket cap that prevents the discharge of solid parts.

Deep bowls This bowls reach an important depth, over 20 cm, thanks to the advanced production technology, that can be offer great capieny and practicity in all the washing operations.

High thickness 1mm thick steel. A significant thickness, which guarantees the maximum sturdiness and durability.

MOULDED BOTTOM The moulded bottom guarantees perfect water flow and facilitates cleaning operations thanks to the perimeter step with sloping walls.

Perimetral overflow The overflow is always a security on the Foster sinks that prevents the overflow of water in case of oversights. The perimeter drain solution improves aesthetics thanks to its square and essential shape.

TECHNICAL DATA

1257/05-

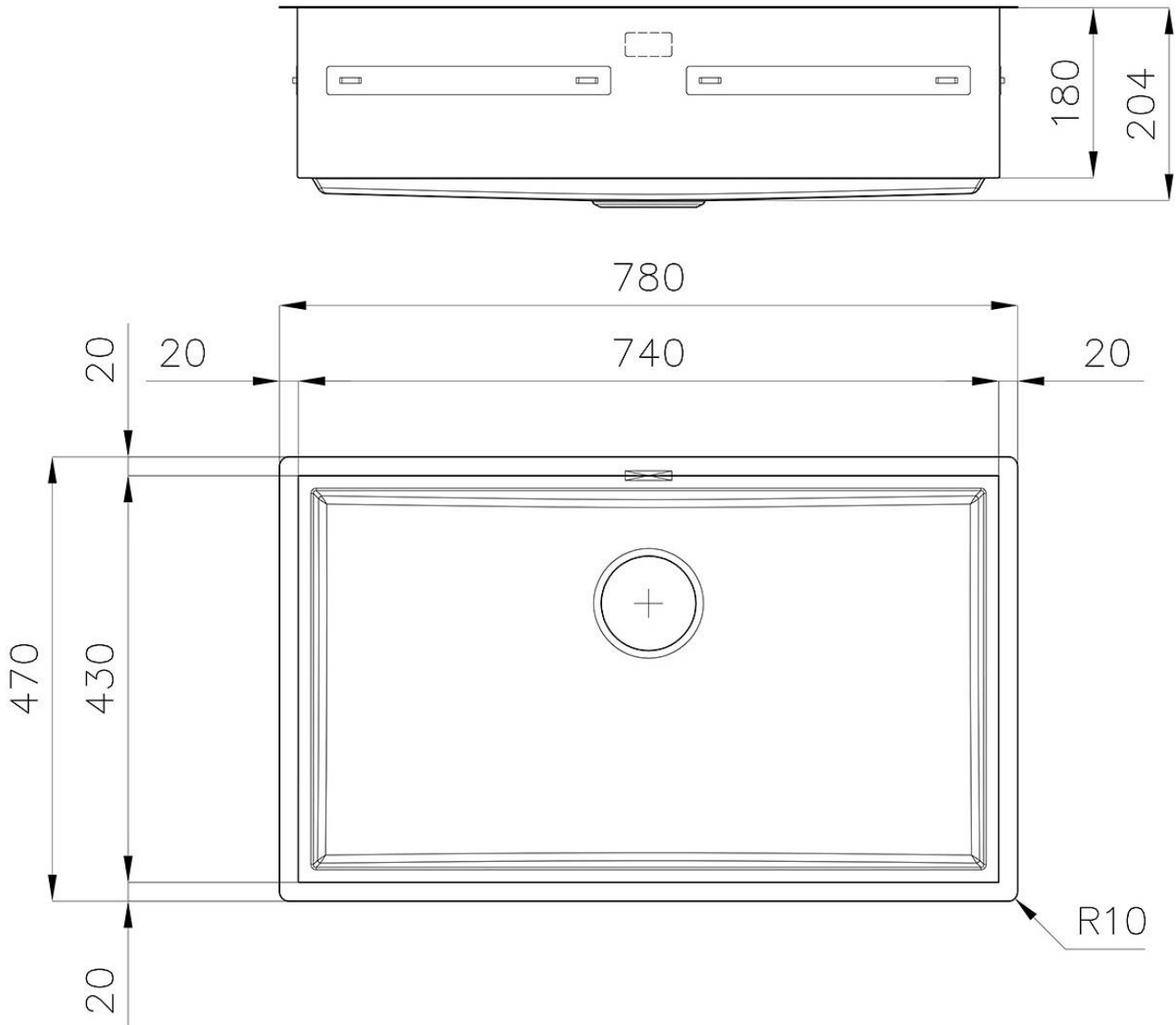

QUADRA EVO **Optional accessories / Accessori opzionali** **FILOTOP / FLUSHMOUNT**

LEVEL 1:

8100 615

8100 614

8100 037

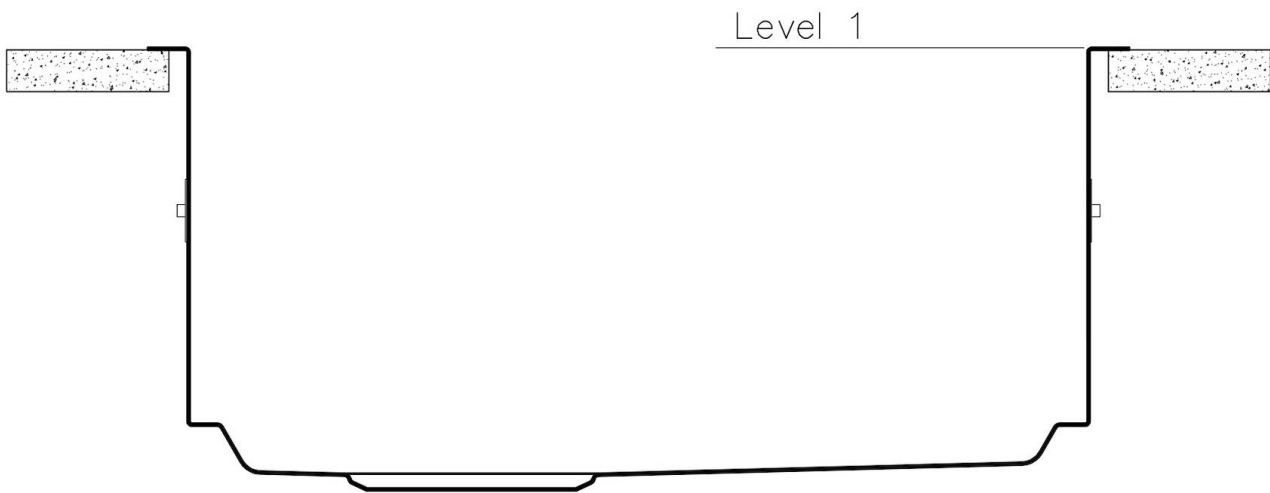

QUADRA EVO **Optional accessories / Accessori opzionali** **FILOTOP / FLUSHMOUNT**

LEVEL 2:

8100 615

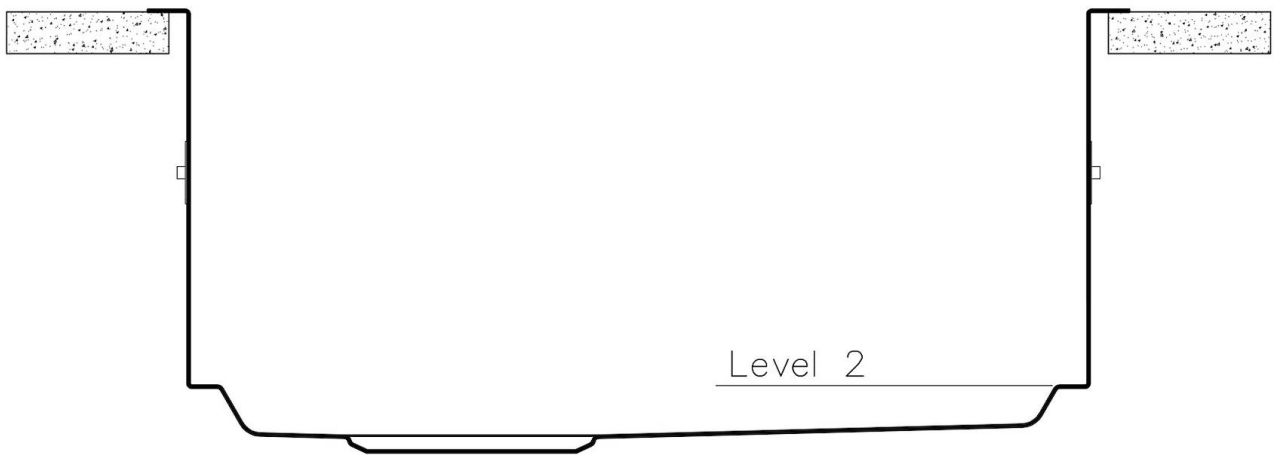

1257/05-

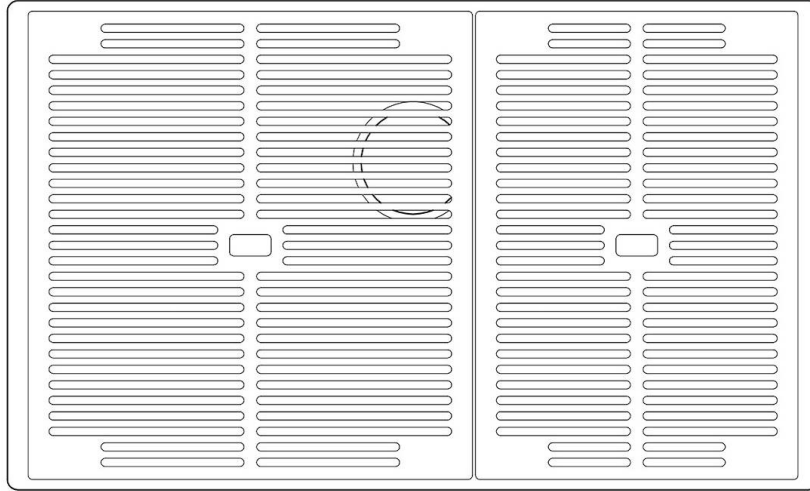

8100 615 + 8100 614
POSIZIONATE A FILO VASCA / EDGE POSITIONING

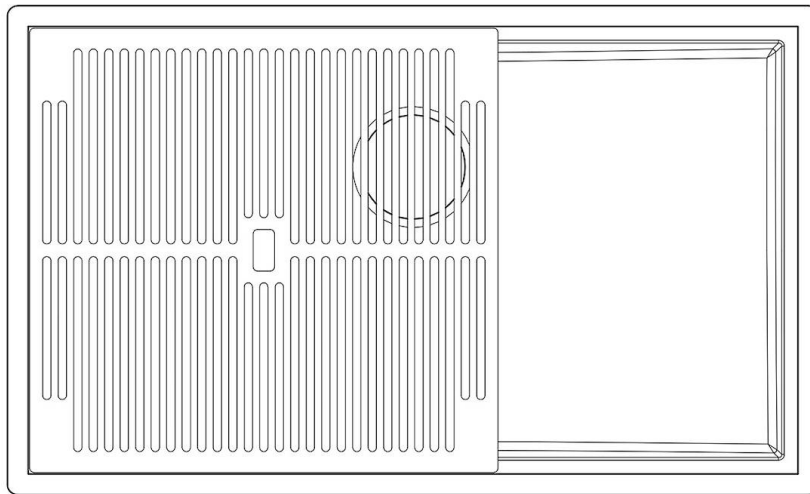

8100 615
POSIZIONATA SUL FONDO / BOTTOM POSITIONING

1255/05-

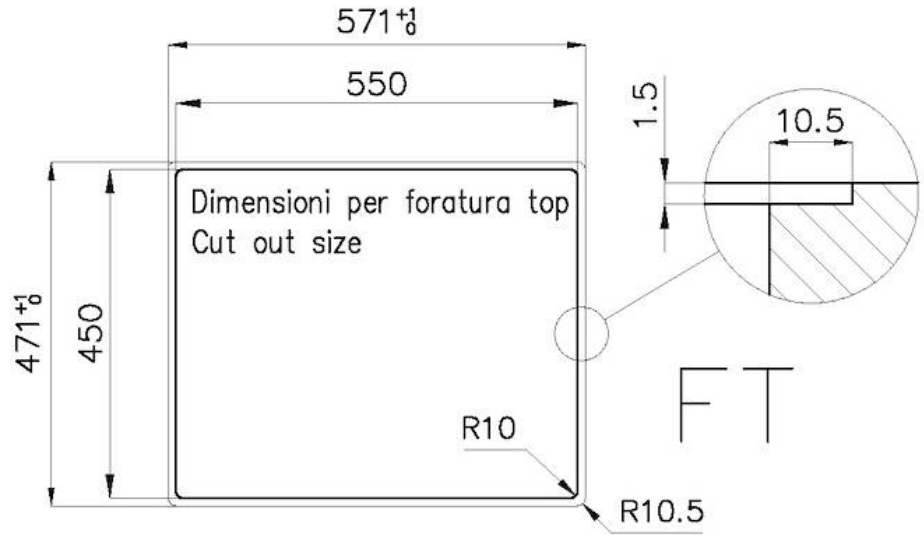

intaglio per il troppo-pieno
solo con top > 10 mm
recess for housing the over-flow
only for top > 10 mm

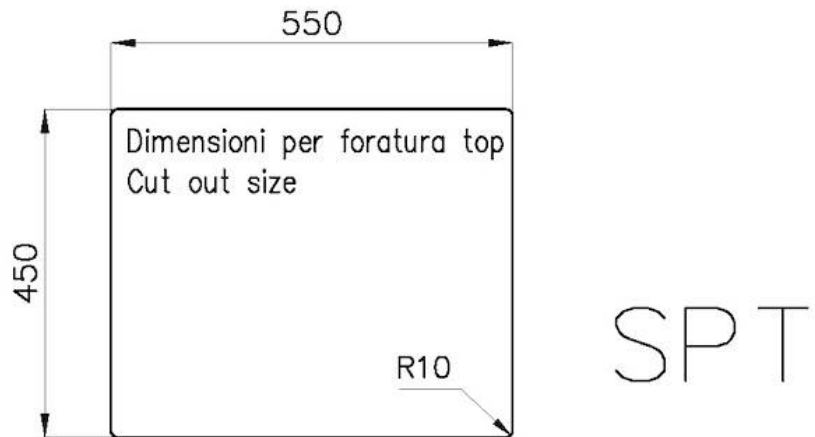
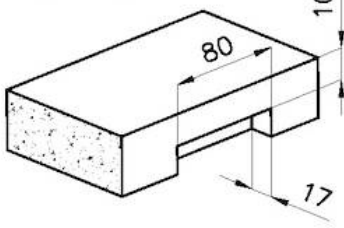

GALLERY

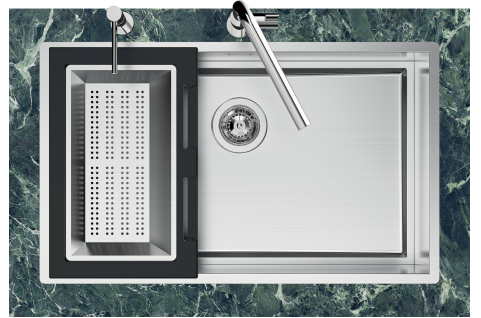
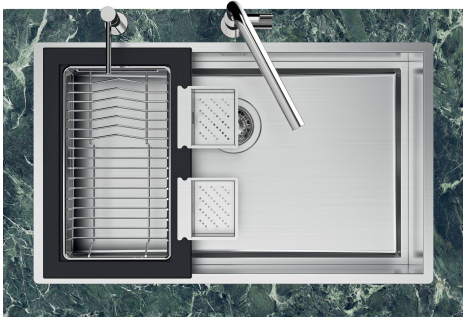
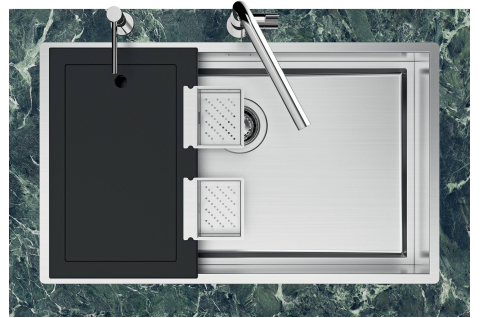
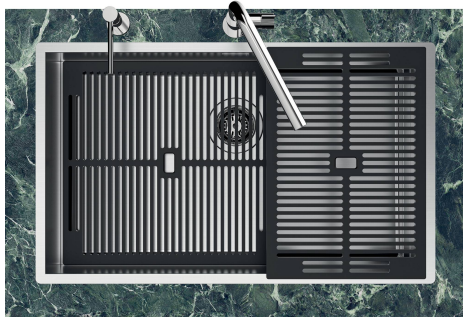
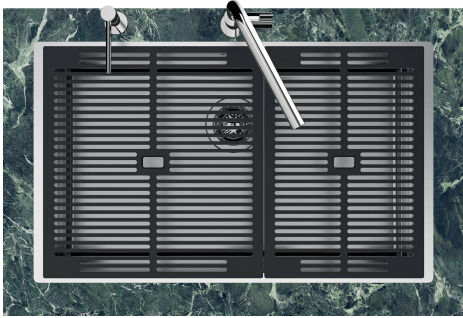

EQUIPMENT



Black grid
8100 615

OPTIONAL ACCESSORIES

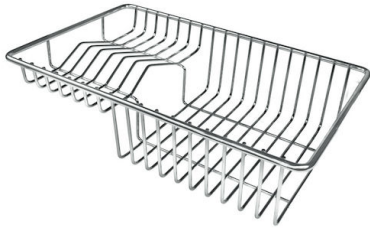

Stainless steel plate rack
8100 303



White bowl
8153 100



Stainless steel perforated tray
8151 001



**Graters kit with ring-holder and
food collection tray**
8159 101



Kit Black
8100 037



Stainless steel colander
8151 010



Stainless steel perforated tray
8151 000



**Stainless steel perforated tray PVD
Copper**
8151 008



**Stainless steel perforated tray PVD
Gold**
8151 009



**Stainless steel perforated tray PVD
Gun Metal**
8151 006

OPTIONAL AUTOMATIC WASTE FITTINGS



Automatic waste fitting - PM
8407 113



**Space Light automatic waste fitting
- PL**
8407 117



**Space Push automatic waste fitting
- PP**
8407 116



Space automatic waste fitting - PA
8407 108